



2 x 2 Seat arrangement



2 x 2 Seat arrangement with middle door

INTERIOR



Tilt & Telescopic steering wheel



Sunvisor



Toilet (option)



Inside rack - Mood lamp (option)



TV & VTR (option)

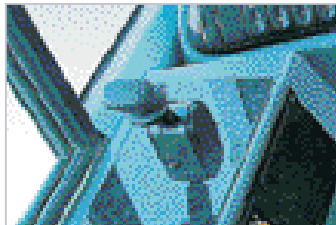

Gradual parking brake (option)

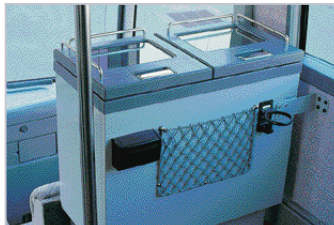

Hot & cold cabinet (option)



Air pressure switch

POWER

DE12, DIESEL

Displacement : 11,051cc
Max horse power : 225ps/2,200rpm
Max torque : 81.5kg.m/1,400rpm



Engine

DV 11, DIESEL(EURO III)

Displacement : 10,964cc
Max horse power : 340ps/1,800rpm
Max torque : 145kg.m/1,200rpm



Engine (option)

POWER

GE12TI, CNG

Displacement : 11,051cc
Max horse power : 310ps/2,100rpm
Max torque : 125kg.m/1,260rpm



Engine (option)

SUSPENSION

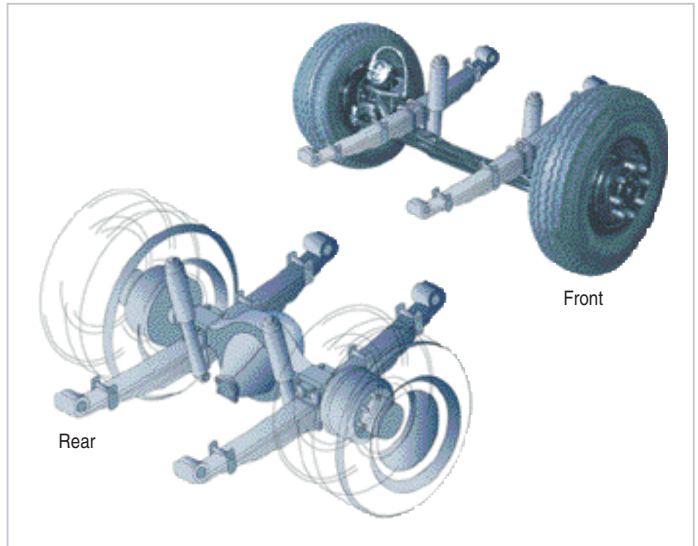

Leaf suspension

EXTERIOR



Outside roof rack (option)



Front / Middle folding door (option)



Water cooler (option)



RHD (option)



Luggage room

BH115E / BH120E STANDARD SPECIFICATION

BH115E

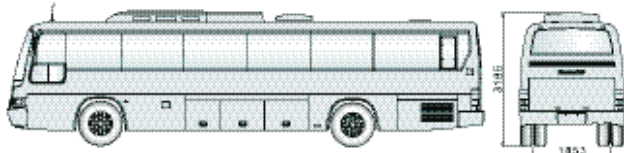
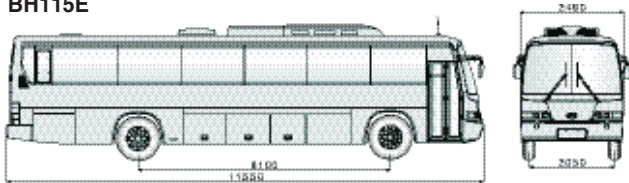

45 +1

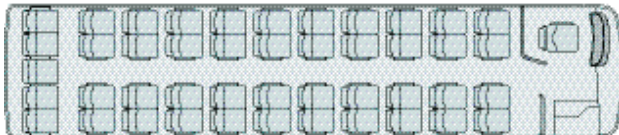

43 +1

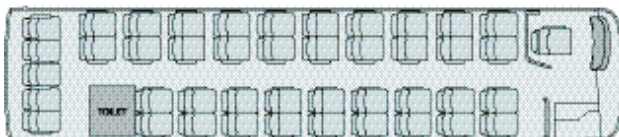

BH120E

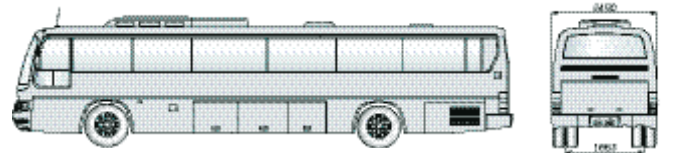
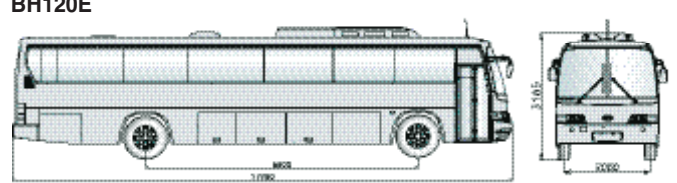

45 +1

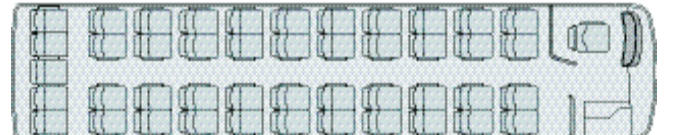

49 +1

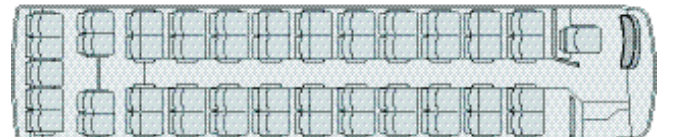

Major Specifications

| | |
|--------------------|--------------------------------|
| BODY STRUCTURE | RIVETLESS SKELETON, STEEL BODY |
| STEERING POSITION | LEFT HAND DRIVE |
| ENGINE MOUNTING | REAR |
| PASSENGER CAPACITY | 45+1 PERSONS |

External Dimensions (mm)

| | BH115E | BH120E |
|-----------------------|--------|--------|
| OVERALL LENGTH | 11,550 | 11,950 |
| OVERALL WIDTH | 2,490 | 2,490 |
| OVERALL HEIGHT | 3,185 | 3,185 |
| WHEEL BASE | 6,100 | 6,500 |
| BODY OVERHANG (FRONT) | 2,270 | 2,270 |
| BODY OVERHANG (REAR) | 3,180 | 3,180 |
| TREAD (FRONT) | 2,050 | 2,050 |
| TREAD (REAR) | 1,853 | 1,853 |

Internal Dimensions (mm)

| | BH115E | BH120E |
|---------------|--------|--------|
| INSIDE LENGTH | 10,685 | 11,085 |
| INSIDE WIDTH | 2,370 | 2,370 |
| INSIDE HEIGHT | 1,970 | 1,970 |

Weight (kg)

| | BH115E | BH120E |
|-------------------|--------|--------|
| PERMISSIBLE G.V.W | 16,500 | 16,500 |
| CURB WEIGHT | 11,150 | 11,250 |
| G.V.W | 14,140 | 14,630 |

Performance

| | BH115E | BH120E |
|---------------------|---------|---------|
| MAX SPEED | 116km/h | 107km/h |
| MIN TURNING RADIUS | 11.5m | 12.1m |
| GRADEABILITY(TANθ) | 0.27 | 0.33 |

Frame

MONOCOQUE TYPE

Engine

| | |
|-------------------|---|
| MODEL | BH115E : DE12, DIESEL BH120E : DE12T, DIESEL |
| TYPE | 4 CYCLE, WATER COOLED |
| NO. OF CYLINDER | 6, IN-LINE |
| BORE & STROKE | 123 X 155mm |
| DISPLACEMENT | 11,051cc |
| MAX HORSE POWER | BH115E : 225ps/2,200rpm BH120E : 300ps/2,200rpm |
| MAX TORQUE | BH115E : 81.5kg.m/1,400rpm BH120E : 110kg.m/1,300rpm |
| COMPRESSION RATIO | 17.1:1 |
| AIR CLEANER | DRY SINGLE PAPER ELEMENT |

Transmission

GEAR BOX 5 FORWARD & 1 REVERSE

| | 1st | 2nd | 3rd | 4th | 5th | REV. |
|--------|-------|-------|-------|-------|-------|-------|
| BH115E | 5.405 | 3.447 | 1.739 | 1.000 | 0.738 | 5.650 |
| BH120E | 6.589 | 4.002 | 2.430 | 1.507 | 1.000 | 6.888 |

SUSPENSION

SEMI ELLIPTICAL ALLOY STEEL HEAVY DUTY LEAF SPRING
WITH HYDRAULIC DOUBLE ACTING TELESCOPIC SHOCK ABSORBER
STABILIZER BAR AT FRONT & REAR

Wheel & Tire

TIRE 10.00-20-16PR TUBE TYPE
WHEEL 7.00T-20 WHEEL

Steering

OPERATION RECIRCULATED BALL WITH INTEGRAL
POWER ASSISTED BY OIL
GEAR RATIO 22.4 : 1
STEERING COLUMN TILT & TELESCOPIC
STEERING WHEEL 2 SPOKE WHEEL WITH HORN BUTTON

Air Service

AIR PRESSURE 9.0kg/cm²
AIR TANK MAIN 50L, BRAKE 25L+35L
AIR TAP FOR TIRE INFLATION
AIR DRYER

Brake

SERVICE BRAKE FULL AIR DUAL CIRCUIT BRAKE SYSTEM
DRUM SIZE FRONT 410mm, REAR 410mm
LINING (w/t) FRONT 155/19mm, REAR 220/19mm
LINING MATERIAL NON-ASBESTOS
PARKING BRAKE SPRING ACTUATOR AT REAR WHEEL
SPRING CHAMBER TYPE
AUXILIARY BRAKE EXHAUST BRAKE-AIR OPERATED

Clutch

TYPE DRY SINGLE PLATE WITH COIL SPRING DAMPER
FACING DIMENSION OUTSIDE DIAMETER 430mm, THICKNESS 5mm
MATERIAL NON-ASBESTOS

BH115E / BH120E STANDARD SPECIFICATION

Axle

| | |
|-------------------|---|
| FRONT AXLE | |
| TYPE | REVERSE ELLIOT 'I' BEAM |
| CAPACITY | 6,000kg |
| REAR AXLE | |
| TYPE | BANJO FULL FLOATING |
| CAPACITY | 10,500kg |
| FINAL GEAR RATIO | BH115E : 39/8(4.875) HYPOID BH120E : 39/10(3.9) HYPOID |

Fuel Tank

320L

Horn

ELECTRIC TYPE

Wiper Arm & Motor

STEEL, VARIABLE SPEED (TIME DELAY RELAY)

Electrical

| | |
|------------|------------------------|
| BATTERY | 12V DC/MF-200AH 2PIECE |
| ALTERNATOR | 24V DC/120AMP |
| STARTER | 24V DC/6.0KW |

Meter & Gauge

TACHOGRAPH (ELECTRICAL WITHOUT RPM GAUGE)
AIR PRESSURE GAUGE
FUEL GAUGE
VOLTMETER
TACHOMETER (RPM METER)
WATER TEMPERATURE GAUGE
ENGINE OIL PRESSURE GAUGE

Seat

| | |
|-----------------------|--------------------------|
| DRIVER SEAT | |
| TYPE | AIR SUSPENSION TYPE |
| UPHOLSTERY | CLOTH COVERING |
| SAFETY BELT | 3 POINT WITH ALARM |
| PASSENGER SEAT | |
| TYPE | RECLINE TYPE |
| UPHOLSTERY | VINYL LEATHER COVERING |
| SAFETY BELT | BUTTON TYPE |
| OTHERS | GRIP, CUP HOLDER, POCKET |

Glass

| | |
|--------------|-------------------------------------|
| WINDSHIELD | 2 SECTION UPPER TINTED LAMINATED |
| SIDE WINDOW | HALF OPENING TYPE TEMPERED GREEN |
| REAR WINDOW | 1 SECTION FIXED TYPE TEMPERED CLEAR |
| DRIVE WINDOW | SLIDING TYPE TEMPERED CLEAR |

Door

| | |
|----------------------|------------------------------------|
| ENTRANCE / EXIT DOOR | FRONT |
| TYPE | 2 SECTION INWARD FOLDING TYPE |
| OPERATING | ELECTRICALLY CONTROLLED AIR ASSIST |

Entrance Step

| | |
|----------------|--|
| NUMBER OF STEP | 2 STEP |
| MATERIAL | FLOOR-PLAIN STEEL+MAT, WALL-STAINLESS ALUMINUM |
| STEP MOULDING | ALUMINUM |

Floor

STEPPED FLOOR
18mm(AISLE) 15mm(STEP) THICKNESS PLYWOOD WITH SMALL COIN PATTERN P.V.C MAT

Audio

| | |
|----------------------|---|
| STEREO W/O ECHO TYPE | AM/FM RADIO, CASSETTE STEREO, 7 SPEAKERS |
| ANTENNA | ROOF HIGH |
| STICK MIC & JACK | |

Interior Equipments

| | |
|-------------------------|---------------------------|
| DEFROSTER | HOT AIR |
| ROOF RACK (INSIDE) | ONE PIECE TYPE |
| ENT. & DRIVER SEPARATOR | F.R.P |
| CEILING HANDLE | P.V.C COATING PIPE(1 ROW) |
| ENTRANCE HANDLE | P.V.C COATING PIPE |
| CURTAIN PROTECTOR | ELASTIC CORD |
| DRIVER CONSOLE BOX | |

Accessories

| | |
|--------------------------|--------------------------------|
| BUMPER(FRONT & REAR) | F.R.P |
| OUTSIDE REAR VIEW MIRROR | CONVEX MIRROR |
| TOWING HOOK | FRONT & REAR |
| FIRE EXTINGUISHER | ABC TYPE (3.3kg) |
| SUNSHADE | CURTAIN TYPE(LH/RH) |
| BATTERY STORAGE | STEEL COMPARTMENT |
| VENTILATOR | 3 LARGE MANUAL HATCHES ON ROOF |
| EMERGENCY HAMMER | 4EA |
| TOOL SET | |

BH115E / BH120E OPTION SPECIFICATION

Options

ENGINE

- DE12TI (310ps/125kgf.m)
- DE12TIS (310ps/125kgf.m, EURO II)
- DL08 (310ps/125kgf.m, EURO III)
- DV11 (340ps/145kgf.m, EURO III)
- GE12TI (310ps/125kgf.m, CNG)

CHASSIS

- RHD
- Auto T/M
- Speed limiter
- Tire-11.00R-20-16PR
- Tire-11.00R-20-16PR
- Tire-11R22.5-16PR
- Tire-12R22.5-16PR
- Auxiliary 110liter fuel tank
- Automatic drain valve
- Coolant corrosion inhibitor filter
- Air pressure check tap
- Anti freeze pump
- Alternator-180AMP
- ABS & ASR
- Heavy duty radiator (without fan clutch)
- Twin air horn
- Dual air cleaner filter element

BODY

- Stainless steel (STS, side & rear)

- Front swing entrance door
 - Emergency door
 - Middle folding exit door
 - Rear folding exit door
 - Acceleration lock (middle)
 - Acceleration lock (rear)
 - Driver door
- ### SEAT
- Passenger seat - Cloth covering
 - Conductor seat - Folding type
 - 37+1 (front door)
 - 39+1 (front/middle door, on floor toilet)
 - 41+1 (front door)
 - 41+1 (front/middle door)
 - 43+1 (front door, on floor toilet)
 - 49+1 (front door)

TRIM

- Small half opening type - Side window
- Large half opening type - Side window
- Colored glass - Bronze
- Destination board - Front, Small
- First aid box
- Curtain assembly - General
- Curtain assembly - Peacock
- Inside rack - One piece

- Inside rack - Clear lamp
- Inside rack - Mood lamp
- Outside roof rack & Ladder
- Toilet (on floor type)

HVAC

- Roof on cooler (24,000 / 26,000 / 28,000 kcal/h)
- Auto ventilator
- Passenger heater
- Preheater

ELECTRICAL

- 14" TV & VCR
- 15" LCD TV & VCR, folding-middle
- 17"/20" LCD TV & VCR
- 'V' type TV antenna
- 'UFO' type TV antenna
- Analog clock
- Digital clock
- Water cooler & tank
- Hot & cold cabinet
- Carvision (back eye camera)
- Stop button buzzer
- Kitchen board
- Stereo double deck type
- Earphone set
- Tachograph (with RPM)



▪ EXPORTER

DAEWOO BUS GLOBAL CORPORATION

202-1, Ojung-dong, Ojung-gu, Bucheon, Gyeonggi-do, Korea
Tel:82-32-680-6611~27 Fax:82-32-680-6610
<http://global.daewoobus.com>

▪ MANUFACTURER

DAEWOO BUS CORPORATION

188-9, Jeonpo-dong, Busan Jin-gu, Busan, Korea
Tel:82-51-811-4210, 520-5166~9 Fax:82-51-811-4055, 521-5147
<http://www.daewoobus.co.kr>





ROYAL ECONOMY

BH115E / BH120E